

095000-0204 CR Fuel Injector Technical Data



SKU: Z1L30950000204

COMMON RAIL

# DIESEL INJECTORS

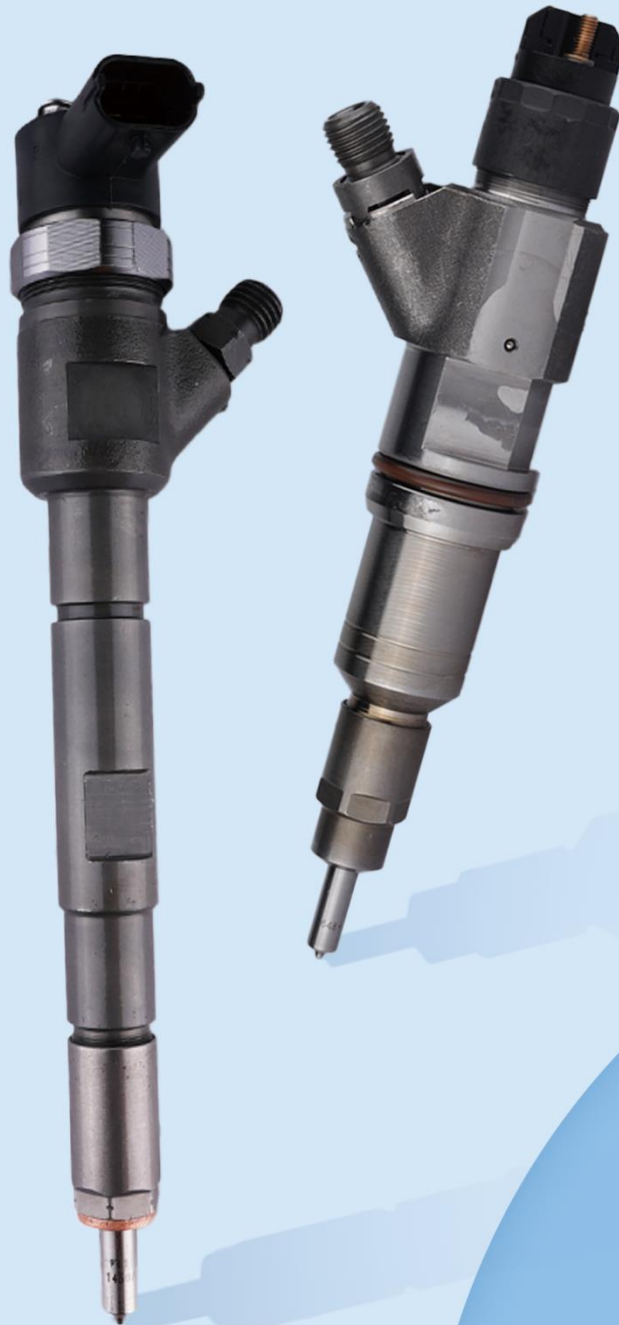

DIESEL  
INJECTORS

## 095000-0204 CR Fuel Injector Technical Data

# Content

1. 095000-0204 CR Fuel Injector Introduction .....	3
1.1. 095000-0204 CR Fuel Injector Basic Information .....	3
1.2. 095000-0204 CR Fuel Injector Common Part Number .....	3
1.3. 095000-0204 CR Fuel Injector Part Number Common Writing .....	3
1.4. 095000-0204 CR Fuel Injector Parameter.....	3
1.5. 095000-0204 CR Fuel Injector Quality Control.....	3
1.6. 095000-0204 CR Fuel Injector Customized Service .....	4
1.7. 095000-0204 CR Fuel Injector Packing List and Package Size.....	4
1.8. 095000-0204 CR Fuel Injector Testing Standard and Certificate .....	6
1.9. 095000-0204 CR Fuel Injector Warranty Instructions .....	6
2. 095000-0204 CR Fuel Injector Technical Support.....	7
2.1. 095000-0204 CR Fuel Injector Part Number Location .....	7
2.2. 095000-0204 CR Fuel Injector Application Scenarios.....	8
2.3. 095000-0204 CR Fuel Injector Installation Precautions.....	9
2.4. Reasons For 095000-0204 CR Fuel Injector Not Working Normally .....	9
2.5. Causes of 095000-0204 CR Fuel Injector Being Damaged.....	9
2.6. 095000-0204 CR Fuel Injector Storage Standard.....	10
2.7. 095000-0204 CR Fuel Injector Technical Support Obtaining Methods.....	11
3. 095000-0204 CR Fuel Injector Purchase and Delivery.....	11
3.1. 095000-0204 CR Fuel Injector Purchase Payment Terms .....	11
3.2. 095000-0204 CR Fuel Injector Main Sales Markets.....	11
3.3. 095000-0204 CR Fuel Injector Declaration Requirements .....	11
3.4. 095000-0204 CR Fuel Injector Shipping Ways .....	11
3.5. 095000-0204 CR Fuel Injector Lead time .....	11
3.6. 095000-0204 CR Fuel Injector Logistics Time for Destination Out of China's Areas .....	12
3.7. 095000-0204 CR Fuel Injector Packing .....	12
5. Company Information.....	13
5.1. Company Introduction.....	13
5.2. Contact Information .....	14
6. Copyright Statement.....	14

## 095000-0204 CR Fuel Injector Technical Data

### 1. 095000-0204 CR Fuel Injector Introduction

#### 1.1. 095000-0204 CR Fuel Injector Basic Information

Title	095000-0204 CR Fuel Injector G2 Series
SKU	Z1L30950000204

#### 1.2. 095000-0204 CR Fuel Injector Common Part Number

##### 1) CR Fuel Injector Exchange Information

CR Fuel Injector Part Number	OE Number
095000-0204	095000-0203

##### 2) CR Fuel Injector Application Information

Injector Part Number	Car Model	Car Model
095000-0204	ME132614	ME302565

##### 3) CR Fuel Injector Matching Information

Vehicle Brand	Car Model	Engine Model	Production Date
MITSUBISHI	FH/FK/FM	6M60T	0202

#### 1.3. 095000-0204 CR Fuel Injector Part Number Common Writing

095000-0200, 095000-0201, 095000-0202, 095000-0203, 095000-0204, 095000-0205, 095000-0206, 095000-0207, 095000-0208, 095000-0209, 095000-020#, 0950000200, 0950000201, 0950000202, 0950000203, 0950000204, 0950000205, 0950000206, 0950000207, 0950000208, 0950000209, 095000020#, ME132614, ME302565

#### 1.4. 095000-0204 CR Fuel Injector Parameter

Adaptation System: [Common Rail System](#)

CR Fuel Injector Series: [G2 Series](#)

CR Fuel Injector Type: [Electromagnetic CR Fuel Injector](#)

Applicable For Vehicle: [HINO](#)

CR Fuel Injector Size: [22cm\\*8 cm \\*4 cm](#)

CR Fuel Injector Net Weight: [0.8kg](#)

CR Fuel Injector Gross Weight: [0.9kg](#)

CR Fuel Injector Quality: [China Made New](#)

CR Fuel Injector Package Size: [24cm\\*12 cm \\*6 cm](#)

CR Fuel Injector Type: [Diesel CR Fuel Injector](#)

CR Fuel Injector MOQ: [4 Pieces](#)

#### 1.5. 095000-0204 CR Fuel Injector Quality Control

##### 1) CR Fuel Injector Testing

All CR fuel injectors are tested for electrical characteristics, accuracy, high temperature, low

temperature, withstand voltage, leakage, durability, and various working conditions.

**2) CR Fuel Injector Assembling**





For quality control during the production and installation process of CR fuel injectors, our company strictly follows the standard product installation data and product installation steps for installation and testing, such as CR fuel injector stroke test, CR fuel injector solenoid valve tightening torque test, CR fuel injector nozzle tightening torque test, etc.

**3) CR Fuel Injector Inspection**

The factory inspection of the CR fuel injector is undergone full inspection, random inspection, and batch inspection three inspections. Different brands of test benches are used to test the same CR fuel injector for a total of more than three times for factory inspection, and the CR fuel injector installation and test environment are progressed in dust-free workshop.

**1.6. 095000-0204 CR Fuel Injector Customized Service**

**1) CR Fuel Injector Customized Service Coverage:** Meet the customized needs of OEM manufacturers for shell lettering, logo engraving, CR fuel injector internal packaging, CR fuel injector external packaging and labels customized, etc.

No.	1	2	3	4
Image				
Name	CR Fuel Injector Nozzle Engraving	CR Fuel Injector House's Lettering	CR Fuel Injector Solenoid Valve Engraving	CR Fuel Injector Box And Label

**2) CR Fuel Injector Customized Service Requirements:**

The purchase of [customized CR fuel injectors](#) are not less than **10 pieces**.



The purchase of [customized CR fuel injector packages](#) are no less than **1000 pieces**.







When the customized products involve the need of specify logo, the OEM manufacturer is asked to provide trademark authorization and the sample of logo image file.

**▲ Once the customized CR fuel injector is sold, it cannot be returned or exchanged if there is no quality problems.**

**1.7. 095000-0204 CR Fuel Injector Packing List and Package Size**

**1) CR Fuel Injector Spare Parts List**

No.	1	2	3
Image			
Name	CR Fuel Injector Assy	O-ring	Nozzle Cover Cap
Description	CR fuel injector part number <a href="#">095000-0204</a>	Ensure to meet the standard of the sealing performance between the CR fuel injector and the engine	Protect nozzle holes from being polluted and blocked

No.	4	5	6
Image			
Name	CR Fuel Injector Shell Protective Cover	Oil Return Protective Cover	VCI Anti-rust Bag
Description	Protect the oil inlet hole from being polluted and blocked	Prevent the oil return from dust and being damaged	Prevent CR fuel injector from rusting
No.	7	8	9
Image			
Name	Bubble Bag	CR Fuel Injector Packing Box	Nozzle Gasket
Description	Prevent the CR fuel injector from being damaged by external forces	Package for CR fuel injector and CR fuel injector accessories	To ensure the tight fit between the CR fuel injector cap end and the engine

- ▲ Minors are forbidden to use the CR fuel injector assembly, O-ring, gasket, nozzle protective cover, CR fuel injector house protective cover, solenoid valve protective cover, VCI anti-rust bag, and air bubble bag to avoid personal injury.
- ▲ O-ring and gasket are disposable installation accessories, and need to be replaced for re-installation.
- ▲ The nozzle protective cover, the CR fuel injector house protective cover, and the solenoid valve protective cover are recyclable accessories that can be reused.
- ▲ VCI anti-rust bags and bubble bags are non-degradable materials, please dispose of them properly after using.
- ▲ The CR fuel injector and the installation parts should be coated with appropriate sealing oil during installation.

## 2) CR Fuel Injector Box Size



Pic No.1

No.	Name	CR Fuel Injector Package Size (cm)
1	CR Fuel Injector Box	24*12*6

**1.8. 095000-0204 CR Fuel Injector Testing Standard and Certificate**

Shumatt can provide the factory quality inspection test report of each CR fuel injector to ensure that each CR fuel injector delivered meets the engine performance indicators.



Pic No.2

**1.9. 095000-0204 CR Fuel Injector Warranty Instructions**

**1) Product Warranty Conditions and Instructions**

It is necessary to provide pictures, videos, or test reports detected by the CR fuel injector inspection equipment as evidence to feed back to the salesman when the CR fuel injector is abnormal during using. Abnormal conditions are properly explained such as: 1.Smoke, 2. Engine shake, 3. Difficulty starting the engine, 4. Engine noise, 5. oil leakage etc.

**2) CR Fuel Injector Warranty Coverage**

Within 15 days after customer receives the 095000-0204 CR fuel injector, if there is a performance failure and the product has no appearance damage, customer can choose to replace it or repair it;

If the 095000-0204 CR fuel injector has performance problems during the warranty period (6-12 months), and it is confirmed that it is product’s problems after testing, you can contact our salesmen to replace the same model or a reworked product with the same performance for free;

If the CR fuel injector house has obvious scratches, it can only be repaired and it will be returned as it is if the product is confirmed to be fault-free.

**▲ Tips:** For products not covered by warranty, our company can provide paid maintenance services. For products after paid repaired, the same performance problem will have a free warranty period within 3 months from the date of repairing.

### 3) CR Fuel Injector Out of Warranty Coverage

- ① The warranty period has expired.
- ② CR fuel injector failure caused by high temperature, high pressure, humidity, rain and snow, saline-alkali land, earthquake, and used in abnormal environment.
- ③ Customer disassembles or repairs the CR fuel injector personally resulting in damage to the CR fuel injector.
- ④ CR fuel injector damage caused by man-made reasons (throwing, strong magnetic field magnetization, set fire).
- ⑤ CR fuel injector failure or CR fuel injector damage caused by non-CR fuel injector design, technology, manufacturing, quality and other issues.
- ⑥ CR fuel injector failure due to system pressure exceeding system approved pressure.
- ⑦ CR fuel injector failure caused by system voltage exceeding approved voltage.
- ⑧ CR fuel injector failure caused by impurities (water, lead, aluminum powder, iron powder, sulfide) in the system fuel exceeding the standard requirements.
- ⑨ CR fuel injector failure caused by not installing according to the tightening torque specified in the vehicle engine maintenance manual (the tightening torque is too large or too small).
- ⑩ CR fuel injector failure caused by not following the installation angle specified in the vehicle engine maintenance manual.
- 11 CR fuel injector failure caused by not following the cleaning requirements specified in the vehicle engine maintenance manual.
- 12 CR fuel injector failure caused by failure to replace consumable parts as specified in the vehicle engine maintenance manual.
- 13 CR fuel injector failure caused by not complying with the intake system fit clearance and exhaust system fit clearance requirements specified in the vehicle engine maintenance manual.
- 14 Failure to replace the consumable parts and the fitting clearance of the oil inlet system pipeline and the CR fuel injector connection in accordance with the fuel intake system specified in the vehicle engine maintenance manual.

## 2. 095000-0204 CR Fuel Injector Technical Support

### 2.1. 095000-0204 CR Fuel Injector Part Number Location

E.g.: See the CR fuel injector part number as follows:



Pic No.3

No.	Name
A	brand, logo, part number, series number
B	nozzle part number

### 2.2. 095000-0204 CR Fuel Injector Application Scenarios

Common rail system is an oil supply method refers to the Fuel oil from the fuel tank sucked out by the gear pump through the oil-water separator and the gear pump to Fuel fine filter, high-pressure pump, common rail pipe, and CR fuel injector, all together with the closed-loop fuel supply system composed of sensors and ECU that completely separates the generation of injection pressure and the injection process from each other.

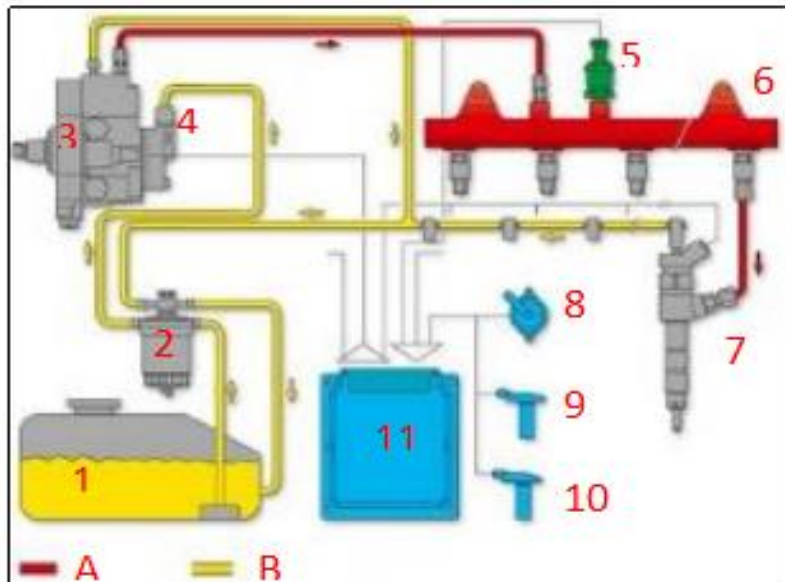

Pic No. 4

No.	Name	No.	Name	No.	Name
1	Tank	6	Common Rail Pipe	11	ECU Electronic Control Unit
2	Fuel Filter	7	CR Fuel Injector	A	High Pressure Oil Circuit
3	High-Pressure Pump	8	Accelerator Pedal	B	Low Pressure Oil Circuit
4	Fuel Gear Pump	9	Engine Crankshaft Sensor	/	/
5	Common Rail Pressure Sensor	10	Camshaft Sensor	/	/



### 2.3. 095000-0204 CR Fuel Injector Installation Precautions

- 1) The replacement of the CR fuel injector must strictly follow the electrical system, the approved pressure of the low-pressure fuel intake system, the approved pressure of the high-pressure fuel circuit system, and fuel system replacement consumables requirements (including the low-pressure fuel circuit system filter and the high-pressure fuel circuit) specified in the vehicle engine maintenance manual;
- 2) Replacement of wearing parts of the fuel system, cleaning requirements for the connection between the fuel system and the CR fuel injector, the fitting clearance of the CR fuel injector connection, the installation angle and tightening torque of the CR fuel injector, the fitting clearance of the intake system, and the fitting clearance of the exhaust system to ensure the service life of the engine and the normal operation of the CR fuel injector.
- 3) When installing the CR fuel injector on the engine, it is necessary to clean the engine block, cylinder head and other parts connected to the CR fuel injector, and ensure that there is no dust, carbon deposits, water, rust spots, etc.
- 4) Before installing, check whether the CR fuel injector nozzle gasket has been replaced and installed on the CR fuel injector.
- 5) When installing the CR fuel injector, apply lubricant between the CR fuel injector, fuel nozzle sealing gasket and O-ring.
- 6) Failure to replace the gasket with a new one may result in: deformation of the tight cap of nozzle, deformation of nozzle, deformation of nozzle orifice, oil leakage and air leakage, which will cause serious damage to the CR fuel injector and nozzle to break and cause damage to the engine.
- 7) When installing the CR fuel injector on the engine, please carefully check the components related to the installation of the CR fuel injector, such as the CR fuel injector pressure plate, screw, CR fuel injector rod and other accessories are not deformed, and install it in strict accordance with the operation steps of the engine maintenance manual.
- 8) It is forbidden to operate the bare CR fuel injector for a long time in an environment with serious dust pollution and corrosion to iron products.
- 9) It is forbidden to operate the bare CR fuel injector for a long time in a strong magnetic field environment.

### 2.4. Reasons For 095000-0204 CR Fuel Injector Not Working Normally

- 1) There is air in the oil circuit of the engine fuel system.
- 2) Vehicle oil pump oil supply system is not normal.
- 3) Engine common rail system oil leakage or pressure limiting valve is damaged.
- 4) There is a short circuit, cutting out and poor contact in the wiring harness connected to the CR fuel injector of the vehicle.
- 5) The long-term placement of the CR fuel injector causes the anti-rust oil to solidify, and the internal components are stuck or the oil holes are blocked.

▲ Before installing, carefully check whether other components in the common rail system except the CR fuel injector is damaged so as to prevent the CR fuel injector from not working properly after being replaced.

### 2.5. Causes of 095000-0204 CR Fuel Injector Being Damaged

- 1) Failure to operate correctly according to the engine maintenance manual during disassembly and assembly resulted in damage to the CR fuel injector.
- 2) The fuel used for the vehicle does not meet the standard, causing damage to the CR fuel injector, such as: the water content in the fuel oil exceeds the standard, iron powder, aluminum powder, sulfide

impurities exceed the standard, etc.

- 3) The engine is not regularly maintained according to the engine maintenance manual (please refer to the vehicle maintenance manual for the maintenance mileage). For example, failure to replace the lubricating oil of the engine system for a long time will cause abnormal wear of the engine, excessive exhaust gas volume or a large amount of carbon deposits inside the engine. The filter is not replaced during maintenance or the replaced filter cannot reach the original filter standard. All above reasons can cause damage to the CR fuel injector.
- 4) The abrasion of the oil pump produces iron powder and aluminum powder enter the CR Fuel injector and cause damage to the CR fuel injector.
- 5) The deformation and abrasion of fuel tank result in iron powder or aluminum powder entering the CR fuel injector and causing damage to the CR fuel injector.
- 6) The CR fuel injector is damaged due to replacement or adjustment of the relevant parts of the CR fuel injector. For example, the valve clearance does not meet the standard after the engine is repaired, the replacement or modification of the wiring harness connected to the CR fuel injector fails to meet the original standard.
- 7) The engine is overheated and overloaded for a long time working results in damage to the CR fuel injector.
- 8) The CR fuel injector will be damaged naturally at the end of its working life.
- 9) The CR fuel injector is magnetized (CR fuel injector parts' magnetic exceeded) causing the CR fuel injector to not work properly.

**▲ Before replacing the CR fuel injector, please check the engine parts carefully according to the engine maintenance manual to avoid the CR fuel injector being damaged again after replacement.**

## 2.6. 095000-0204 CR Fuel Injector Storage Standard

### 1) Choose a Suitable Storage Place

The warehouse and cargo yard where the CR fuel injector is stored should be kept clean and dry, and away from the factory buildings that generate harmful gases and dust; do not mix with acid, alkali, salt and other substances; the storage place should have a good drainage system; the cargo yard should be flattened with gravel or furnace ash etc. to enhance the water permeability of the surface layer to keep the reservoir area dry.

### 2) Strict Requirements of Warehousing

Strict inspections should be carried out when the CR fuel injectors are put into storage, the surface cleaning work should be done well to remove water traces, oil stains, ash and other dirt, remove the rust and do anti-rust treatment in time. Packaged CR fuel injectors must be protected from damage.

### 3) Keep The Warehouse Dry And Preventing Moisture

The relative humidity is usually below 70% for the CR fuel injectors placed in the room, and the corrosion of the CR fuel injectors is significantly reduced.

CR fuel injectors must be stored in the warehouse, and they are forbidden to store in the same warehouse with commodities with high water content.

### 4) Stack Properly

**▲** After the CR fuel injector is exposed to rain, the corrosion rate will increase significantly. The purpose of sealing is to isolate the CR fuel Injector from rainwater and humid air, so the warehouse window should be checked in time to avoid rainwater entering the warehouse.

If the CR fuel injector package is damaged, it should be repaired or replaced; when the package is damp, the packaging material should be dried; if the original anti-corrosion and oil applied at the factory is found to be damaged or dried up, it should be cleaned and re-applied oil in time.

- ▲ It is forbidden to leave the CR fuel injector exposed in the air for a long time.
- ▲ It is forbidden to store acid, alkali, salt and other substances together with the CR fuel injector.
- ▲ The unpacked CR fuel injector must be rust-proof during secondary storage.

## 2.7. 095000-0204 CR Fuel Injector Technical Support Obtaining Methods

- 1) CR Fuel Injector Technical Data: <https://www.crinjectors.com/download/>
- 2) CR Fuel Injector Videos: <https://www.crinjectors.com/videos/>
- 3) CR Fuel Injector Encyclopedia: <https://www.crinjectors.com/category/news/encyclopedia/>
- 4) CR Fuel Injector Information Query Software:

TruckBook Parts EPC APP, Android/Apple App Store download and install, visit <http://shumatt.com> to get the download and installation tutorial.

- 5) YouTube:

Visit [https://www.youtube.com/channel/UCByvYBx7VjV\\_mAfxh\\_Hu-aw](https://www.youtube.com/channel/UCByvYBx7VjV_mAfxh_Hu-aw) to get the technical videos, stay tuned for more information.

## 3. 095000-0204 CR Fuel Injector Purchase and Delivery

### 3.1. 095000-0204 CR Fuel Injector Purchase Payment Terms

**Payment Terms:** T/T, PayPal, Alipay, WeChat

- ▲ Please contact our salesmen for specific payment information.

### 3.2. 095000-0204 CR Fuel Injector Main Sales Markets

**CR Fuel Injector Main Sales Markets:** Asia, Europe, North America, South America, Africa etc.

### 3.3. 095000-0204 CR Fuel Injector Declaration Requirements

Shumatt can assist customers to provide the following documents for import customs clearance: contract, invoice, packing list, bill of lading, insurance policy, certificate of origin, etc.

### 3.4. 095000-0204 CR Fuel Injector Shipping Ways

**Destination in China Areas:** SF Express, Debon Express, the corresponding logistics company can be provided according to customer requirements in special cases.

**Destinations Out of China's Areas:** DHL, UPS, FedEx, TNT air, ocean or other shipping methods required by customers.

### 3.5. 095000-0204 CR Fuel Injector Lead time

**Lead Time:** Send out within 3 – 7 working days after receiving payment (Except for special products and special cases).

**3.6. 095000-0204 CR Fuel Injector Logistics Time for Destination Out of China's Areas**

**DHL Logistics Time :**

Country or Region of Departure	Hong Kong, China	Other Countries or Regions of Asia	Australia and New Zealand	Europe	America	Other Countries
China's Mainland	7 Days	7 Days	8 Days	8 Days	8-12 Days	7-10 Days

**UPS Logistics Time: Country or Region of Departure: China's Mainland**

Country of Destination	Estimated Arrival Time	Country of Destination	Estimated Arrival Time	Country of Destination	Estimated Arrival Time
Japan	3 Days	UK	5-7 Days	Egypt	5-7 Days
Turkey	5-7 Days	Singapore	3 Days	Switzerland	5-7 Days
Bahrain	5-7 Days	Latvia	7-10 Days	New Zealand	7-10 Days
Sri Lanka	5-7 Days	Thailand	3 Days	Austria	5-7 Days
Romania	5-7 Days	Vietnam	3-5 Days	Estonia	5-7 Days
Malaysia	3-5 Days	Israel	5-7 Days	Mexico	7-10 Days
France	5-7 Days	America	5-7 Days	United Arab Emirates	5-7 Days
Italy	5-7 Days	Netherlands	5-7 Days	Bengal	7-10 Days
Lebanon	5-7 Days	Philippine	3-5 Days	Greece	7-10 Days
South Korea	3 Days	Spain	5-7 Days	Myanmar	5-7 Days
Canada	5-7 Days	Germany	5-7 Days	Saudi Arabia	7-10 Days
Portugal	5-7 Days	Australia	5-7 Days	South Africa	7-10 Days
Denmark	5-7 Days	Belgium	5-7 Days	Ukraine	7-10 Days
India	7-10 Days	Qatar	7-10 Days	Poland	5-7 Days
Indonesia	3-5 Days	Morocco	7-10 Days	Pakistan	7-10 Days
Kuwait	7-10 Days	/	/	/	/

**▲ The logistics time is for reference only and is subject to the actual arrival.**



**3.7. 095000-0204 CR Fuel Injector Packing**

**Domestic Express Packaging:** Usually wrapped in waterproof scotch tape.

**International Express Packaging:** Wrapped with waterproof yellow tape after wrapping the black protective.

**Pallet Shipping:** Use fumigation free and recycling trays that meet export requirements, and use white wrapping protective film to wrap and bind with cable ties for the outside, also, the products can be packaged according to customers' requirements.

- ▲ The packing tray is made of plastic and can be recycled.**
- ▲ Transparent tape, yellow tape, black wrapping protective film, white wrapping protective film are non-degradable materials, please dispose of them properly.**
- ▲ Minors are prohibited from using transparent tape, yellow tape, black wrapping protective film, and white wrapping protective film to avoid personal injury.**

No.	1	2	3
Image			
Name	Domestic Express Packaging	International Express Packaging	Pallet Shipping
Description	Wrapped by transparent tape	Wrapped with yellow tape after wrapping black protective film	Use pallet that meet export requirements, and use white wrapping protective film to wrap and bind with cable ties

### 5. Company Information



Pic No. 5

#### 5.1. Company Introduction

**Chinese Name:** 深圳市舒马特科技有限公司

**English Name:** Shenzhen Shumatt Technology Co., Ltd

**CR Fuel Injector Manufacturer:** Shenzhen Shumatt Technology Co., Ltd

 **Mob Phone/WeChat:** +86-13410541523

 **HK Telephone:** +852-67653519

 **Telephone:** +86-755-23215133

 **Email:** [ruby@shumatt.com](mailto:ruby@shumatt.com)

 **Website:** [www.shumatt.com](http://www.shumatt.com)

 **Shenzhen Office:** 11-12, Floor 14, Building 13, Qinchengda Building, Exit A, Honglang North Subway Station, Bao'an District, Shenzhen, China's Mainland

 **Shenzhen Office:** Exit C, Qiao Touxu Metro Station, NO. 66 Chongqing Road, Fuhai Avenue, Bao'an District, Shenzhen, China Mainland

 **Hong Kong Office:** Jianfa Street Industrial Zone, Tuen Mun, New Territories, Hong Kong, China

 **After-sales Service Address:** Please contact our salesmen to obtain and provide the corresponding product maintenance reasons (Reference: [1.9. 095000-0204 CR Fuel Injector Warranty Instructions](#).)

## 5.2. Contact Information

Name	WeChat/ WhatsApp	Email
Ruby	+86-13410541523	<a href="mailto:hison@shumatt.com">hison@shumatt.com</a>

## 6. Copyright Statement

Without written authorization from Shenzhen Shumatt Technology Co., Ltd, no media or individual may use the content in " [095000-0204 CR Fuel Injector Technical File](#)" for commercial purposes (including but not limited to modifying, republishing, copying, intercepting, reproducing, and disseminating any part of this work), otherwise it will be deemed as infringement. Any media or individual who commits the above-mentioned infringement must immediately stop the behavior and bear full responsibility for all adverse consequences caused thereby. Shenzhen Shumatt Technology Co., Ltd. reserves the right to pursue its economic and legal responsibilities in accordance with the property rights law and relevant laws and regulations.

If there is any question, please contact us via [hison@shumatt.com](mailto:hison@shumatt.com).